

UNDER COUNTER GLASS DOOR _S SERIES

SGR9-1

FEATURES / BENEFITS

FRONT BREATHING

Our innovative, front breathing feature also allows this model to provide high efficiency in narrow spaces

HOT GAS CONDENSATE SYSTEM

Through SKIPIO's creative innovation, the condensate system surfaces have been specially treated to resist corrosion. This not only increases efficiency without the risk of refrigerant leakage from corrosion, but also prevents the overflow of condensate water.

SIDE MOUNT COMPRESSOR UNIT

By positioning the compressor on the side of the unit, refrigerators can now be serviced without being moved

EFFICIENT REFRIGERATION SYSTEM

SKIPIO Undercounter series refrigerators are designed with oversized and balanced (CFC Free R-134A) refrigeration systems. These include efficient evaporators and condensers for faster cooling and greater efficiency.

EXTERIOR & INTERIOR OF THE CABINET

SKIPIO Undercounter series boasts a stainless steel exterior (galvanized steel back and bottom). Interior is stainless steel floor with AL sides, back and AL door liners. It guarantees the utmost in cleanliness and long product life. It can add a touch of style to the most refined setting.

HIGH-DENSITY POLYURETHANE INSULATION

The entire cabinet structure and solid doors are foamed-in-place using high density, CFC free polyurethane insulation

ERGONOMICALLY DESIGNED DOORS

Customers' fatigue fades away with easy grip handles and doors that open effortlessly. These features along with self-closing doors make this the ultimate choice in customer convenience

MAGNETIC DOOR GASKETS

Magnetic door gaskets are of one piece construction, removable without tools for ease of cleaning and replacement.

ADJUSTABLE, HEAVY DUTY, PE (POLYETHYLENE) COATED WIRE SHELVES



Model	Doors	Capacity (Liters)	Shelves	Compressor (HP)	Amps (A)	Weight (Kg)	L X D X H (mm)
SGR9-1	1	121	1	1/4	2.3	80	900x700(600)x855

Model: SGR9-1

SPEC SHEET	SGR9-1
Classification	Refrigerator
Cabinet Dimension (WxDxH mm)	900x700(600)x855
Capacity (Liters)	121
Inner Temperature	1°C~8°C
Doors	1
Number of Shelves	1
Refrigent	R-134a
Compressor (Hp)	1/4
Lamp	LED lamp
Cooling Type	Fan cooling type
Insulation Type	Polyurethane / Cyclopentane + CFC Free
Temperature Control Type	Digital
Amps (A)	2.3
Voltage (V/Hz/Ph)	240V 50Hz 1Ph
Power (W)	314
Weight (Kg)	80

PLAN VIEW

(unit: mm)

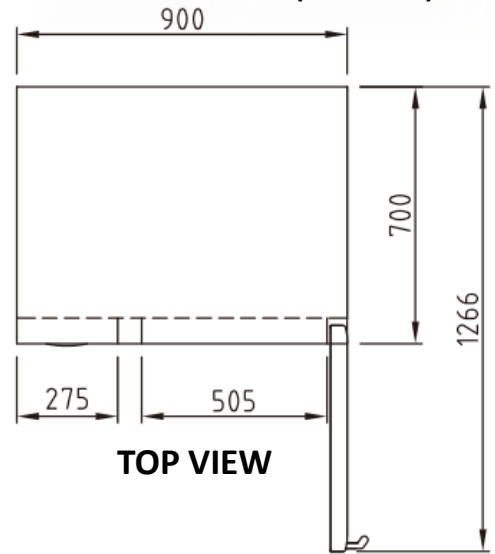

TOP VIEW

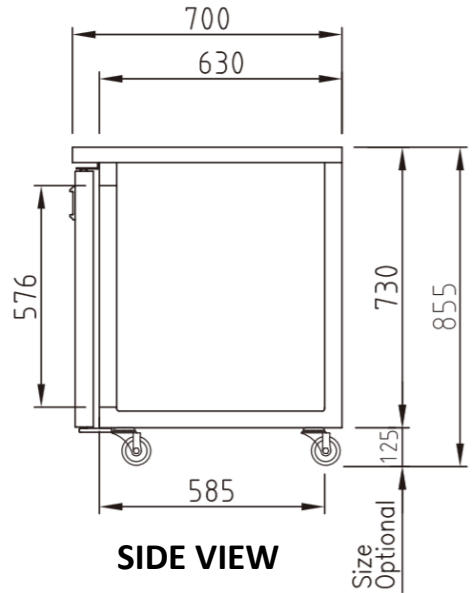

SIDE VIEW

WARRANTY 2 YEARS
PARTS & LABOUR



■ ADD : 218 WOODPARK ROAD SMITHFIELD NSW 2164
 ■ TEL : 02 - 8798 - 5061 / 5283 / 5581
 ■ FAX : 02 - 8798 - 5707