

SIS Series Ice Shuttle System - up to 318kg

SIS 700



- Storage capacity up to 318kg
- Includes 1 x 73kg ice cart
- Ice chute cut-out required upon installation
- Upright front bin with incorporated ice shuttle carts
- Stainless steel exterior for both storage and frame
- Pre-cut top pane to accommodate multiple head units
- To accelerate flow during ice extraction, ice paddle (and hanging bracket) are available standard
- The shuttle cart is filled through a sliding guillotine, easy to open
- Insulated top closed with lid on storage
- Spring loaded storage compartment bin door for safe operation
- High density polyethylene insulation
- Pre-assembled heavy-duty frame with hosting base with built-in drain for bin and cart (reversible drain connection)
- Includes ice paddle, water and drain hose

SIS Series Ice Shuttle System - up to 318kg

SIS 700

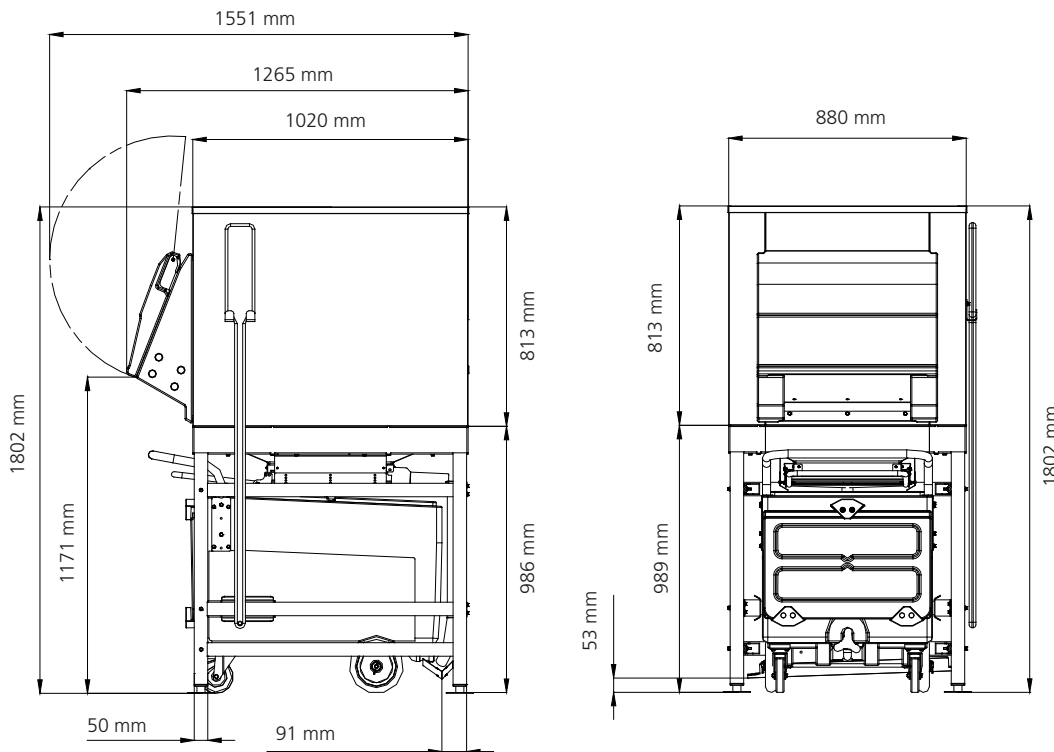

moffat.com.au

Australia
Moffat Pty Limited
Victoria/Tasmania
740 Springvale Road
Mulgrave, Victoria 3170
Telephone 03-9518 3888
Facsimile 03-9518 3833
vsales@moffat.com.au

New South Wales
Telephone 02-8833 4111
nswsales@moffat.com.au

South Australia
Telephone 03-9518 3888
vsales@moffat.com.au

Queensland
Telephone 07-3630 8600
qldsales@moffat.com.au

Western Australia
Telephone 08-9413 2400
wasales@moffat.com.au

Dimensions

Width: 880mm
Depth: 1265mm
Height: 1802mm
Nett weight: 161kg
Packed weight: 198kg

Ice capacity (application)*
318kg

Ice capacity (AHRI)**
249kg

Internal Volume
0.684m³



* Application capacity is calculated on 90% of total volume x 545 kg/m³



** AHRI capacity is calculated on 80% of total volume x 481 kg/m³

Important Notice:
Models and specifications are subject to change without notice. This spec sheet is meant for commercial purpose only. For technical documentation please refer to our service manuals.



© Copyright Moffat Ltd
AU.SM.1801

an Ali Group Company



The Spirit of Excellence