



# VERRO SERIES: VHCBR-3

## Char Broiler 300mm

Project: \_\_\_\_\_ Item: \_\_\_\_\_



VHCBR-3

### Standard Features:

- AISI 304 grade stainless steel
- Heavy duty complete stainless-steel frame
- 26MJ stainless steel burner and two radiant hoods per 300mm section
- Heavy duty cast iron J grates
- Multi-setting gas valve as standard allowing for greater regulation of flame setting
- Piezo ignition and flame failure device
- Easy to clean fat spillage trays
- Easy access to all components for servicing and adjustment
- 24-month warranty

### Options:

- Natural or LP gas

### Specifications:

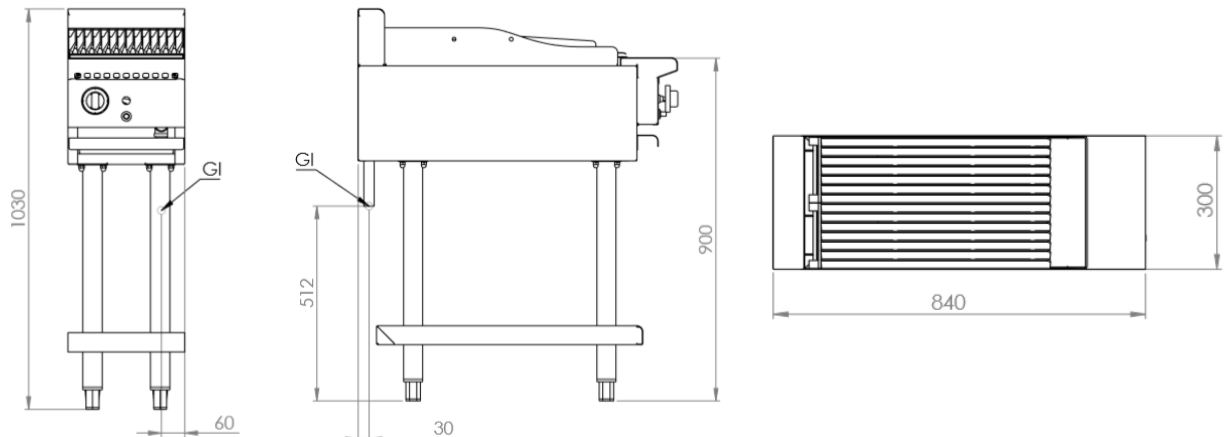

MODEL	LENGTH (mm)	DEPTH (mm)	HEIGHT (mm)	GAS CONSUMPTION (Mj/h)	
				NG	LPG
VHCBR-3	300	840	1030	33	30

### Connections:

GAS (GI) (BSP)	SUPPLY PRESSURE (kPa)	
	NG	LPG
3/4" (M)	1.0	2.6

- Regulator is included in the unit
- **Must** be installed by an authorised installer

**Due to ongoing Product Development, Product Improvement and Research, B+S Commercial Kitchens reserves the right to alter specification without notice.**



B+S Commercial Kitchens  
 57 Plateau Road Reservoir VIC 3073 Australia | +61 3 9469 4754  
 info@bscommercialkitchens.com | www.bscommercialkitchens.com

