

J 100 Ultra



D

Juice extraction rate	160 litres/hour
-----------------------	-----------------

A glass of ultra-fresh juice in just 7 seconds

A SALES FEATURES

With the J 100 Ultra, you can juice all types of fruit and vegetables in a matter of seconds. Equipped with a continuous-flow ejection chute for even greater user convenience.

B TECHNICAL FEATURES

J 100 Ultra juicer – 230V/50Hz/1ph. Power: 1,000 W. Constant speed: 3,000 rpm. Magnetic safety device and motor brake. Stainless-steel bowl and motor unit. Equipped with a large patented automatic feed tube (Ø 79 mm). Stainless-steel juicer basket, grating disc and filter. Extraction rate: 160 l/h, equivalent to one glass of fresh juice every 7 s. Supplied with both an ejection chute (strap supplied), designed to send a continuous flow of pulp directly into a bin under the worktop, and a 7.2-litre, large-capacity pulp container, plus a drip tray and a special no-splash spout.

STANDARDS
 EN 12100-1 and 2 - 2004, EN 60204- 1 - 2006,
 EN 1678 - 1998, EN 60529-2000: IP 55, IP 34.



E PRODUCT FEATURES

MOTOR BASE

- Induction direct drive motor for intensive use.
- Very powerful, heavy-duty motor so quiet it can be used right in front of the customer.
- Power: 1,000 W.
- Stainless-steel bowl and motor unit.
- Magnetic safety device and motor brake.
- Constant speed: 3,000 rpm.

JUICER FUNCTION

- All-metal juicer boasting our Auto Feed system (Ø 79 mm = whole apple) for continuous throughput.
- Stainless-steel juicer basket, grating disc and filter for easy cleaning and aftercare.
- No-splash spout.
- High clearance (256 mm), allowing a jug or cocktail glass to be placed underneath the spout.
- Two ways of using your juicer:
 - an ejection chute sends a continuous flow of pulp directly into a bin under the worktop.
 - pulp goes into a 7.2-l, large-capacity container with translucent sides.

C TECHNICAL DATA

Power	1,000 Watts
Electrical datas	Single phase - plug supplied
Constant speed	3,000 rpm
Dimensions (LxWxH)	235 x 538 x 596 mm
Gross weight	15.6 kg
Supply	230V/50/1
Reference	56102A

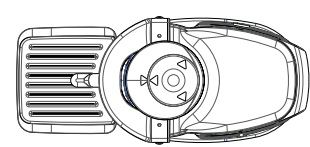
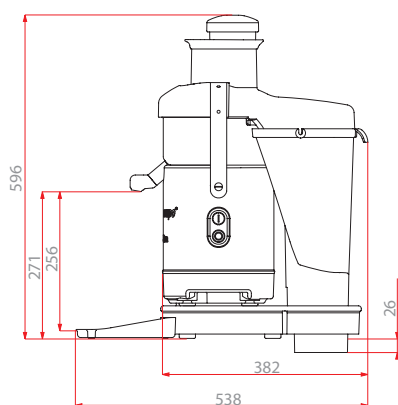
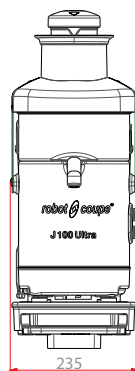

Hole to be cut in worktop: Ø 100 mm

